

Quad DC/DC Converter for Triple Output TFT Supply Plus LED Driver

FEATURES

- Triple Output TFT Supply with Built-In Power Sequencing
- Integrated White LED Backlight Driver
- Integrated Schottky Diodes
- Active Ballast Circuitry Ensures Precise Current Matching in White LEDs
- Low Noise 1MHz Fixed Frequency Operation
- 2.6V to 16V Input Voltage Range
- Soft-Start Limits Inrush Current
- TFT Supply Output Voltages Independently Set (Not Charge Pump Derived)
- Power Good and Output Disconnect for TFT Supply
- Built-In LED Dimming Capability
- Open LED Protection for LED Driver
- 24-Lead QFN Package (4mm × 4mm)

APPLICATIONS

- Poly-Silicon TFT Displays
- Amorphous Silicon TFT Displays

DESCRIPTION

The LT[®]1942 is a highly integrated quad switching regulator designed to provide all necessary power supply functions for TFT displays, including the white LED backlight driver. The TFT supply incorporates two boost and one inverting DC/DC converters. The TFT supply output voltages are independently set, unlike charge pump solutions which have many limitations. Power sequencing for the TFT supply is built into the part and is user programmable.

The LED driver is a boost DC/DC converter that can be independently controlled. The LED driver has built-in dimming control for precise control of LED current. An 8:1 dimming range is achieved by adjusting the CTRL4 voltage. The user can elect to drive a single string or two strings of LEDs. An LED ballast circuit is included to precisely match the LED currents if two strings of LEDs are used. Soft-start is built into the LED driver as well as the primary TFT supply.

The LT1942 is available in a low profile (0.75mm) 24-lead QFN (4mm × 4mm) package.

LT, LTC and LT are registered trademarks of Linear Technology Corporation.

TFT Bias and White LED Backlight Power Supply

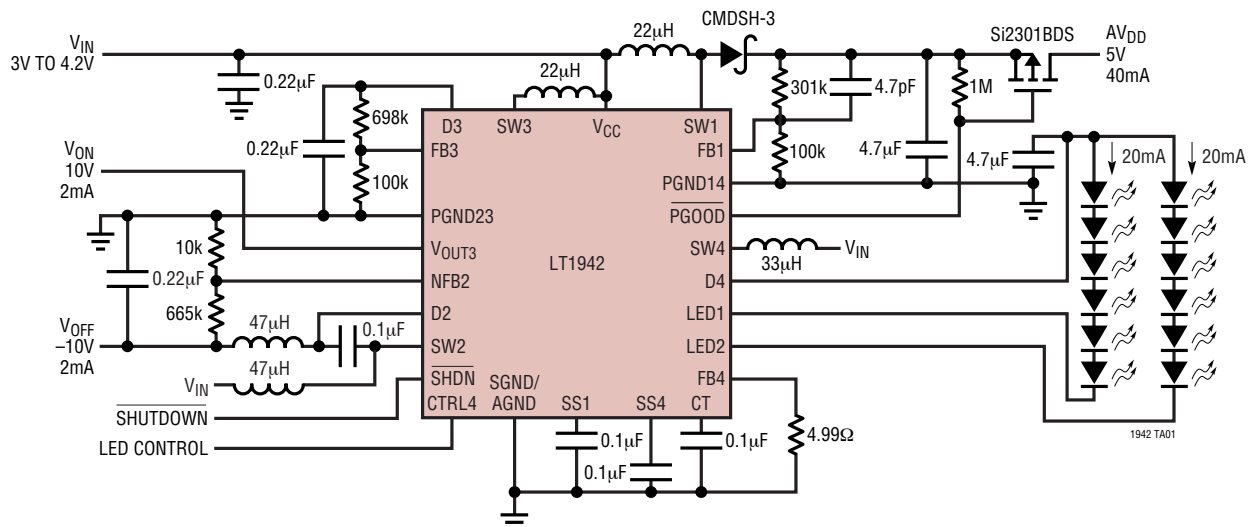

sn1942 1942fs

ABSOLUTE MAXIMUM RATINGS

(Note 1)

V_{CC} Voltage	16V
SW1, SW2, SW3 Voltage	-0.4V to 36V
SW4	-0.4V to 45V
FB1, FB3 Voltage	2.5V
FB4 Voltage	400mV
NFB2 Voltage	-200mV
SHDN Voltage	10V
CTRL4 Voltage	16V
SS1, SS4 Voltage	1.5V
Current Into D2	1A
D2 Voltage	-36V
Current Out of D3	1A
D3 Voltage	36V
Current Out of D4	4A
D4 Voltage	45V
LED1, LED2 Voltage	45V
Current Into LED1, LED2	35mA
PGOOD Voltage	16V
V_{OUT3} Voltage	36V
CT Current	± 1 mA
Maximum Junction Temperature	125°C
Operating Temperature Range (Note 2) ..	-40°C to 85°C
Storage Temperature Range	-65°C to 125°C

PACKAGE/ORDER INFORMATION

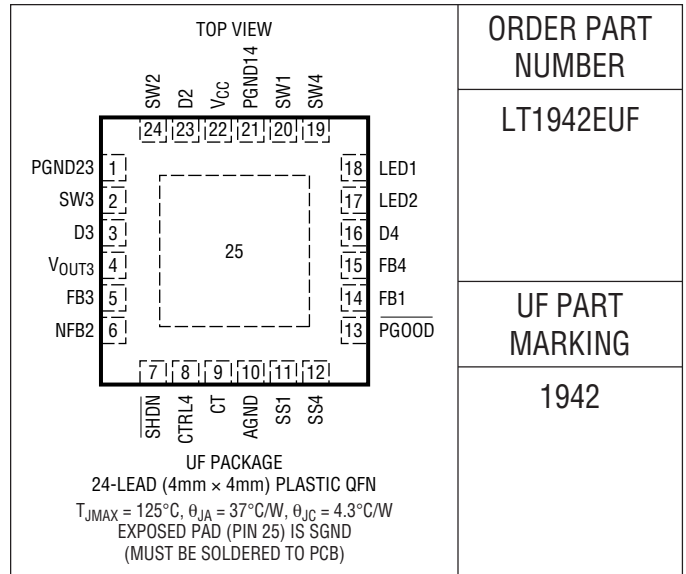

ORDER PART NUMBER

LT1942EUF

UF PART MARKING

1942

Consult LTC Marketing for parts specified with wider operating temperature ranges.

ELECTRICAL CHARACTERISTICS

The ● denotes the specifications which apply over the full operating temperature range, otherwise specifications are at $T_A = 25^{\circ}\text{C}$. $V_{IN} = 3.3\text{V}$, $V_{SHDN} = V_{IN}$, unless otherwise noted. (Note 2)

PARAMETER	CONDITIONS		MIN	TYP	MAX	UNITS
Quiescent Current	$V_{SHDN} = 3.3\text{V}$, $V_{CTRL4} = 0\text{V}$, Not Switching	●		7	10	mA
	$V_{SHDN} = V_{CTRL4} = 0\text{V}$, In Shutdown	●		0	1	μA
Input Voltage Range	V_{CC} Pin	●	2.6		16	V
AV_{DD} Feedback Voltage	FB1 Pin	●	1.225	1.25	1.275	V
AV_{DD} Feedback Pin Bias Current (FB1)	FB1 Pin (Note 3)			15	60	nA
AV_{DD} Feedback Voltage for Power Good Signal	FB1 Pin Voltage as a Percent of Nominal Voltage	●	95	97	100	%
V_{OFF} Feedback Voltage	NFB2 Pin		-160	-150	-140	mV
V_{OFF} Feedback Pin Bias Current (NFB2)	NFB2 Pin (Note 3)			25	60	nA
V_{ON} Feedback Voltage	FB3 Pin		1.225	1.25	1.275	V
V_{ON} Feedback Pin Bias Current (FB3)	FB3 Pin (Note 3)			25	60	nA
LED Feedback Voltage	FB4 Pin	●	190	200	210	mV
LED Feedback Pin Bias Current (FB4)	FB4 Pin (Note 3)			20	60	μA
LED Feedback Voltage with Dimming	$V_{CTRL4} = 1\text{V}$		85	95	105	mV

ELECTRICAL CHARACTERISTICS

The ● denotes the specifications which apply over the full operating temperature range, otherwise specifications are at $T_A = 25^\circ\text{C}$. $V_{IN} = 3.3\text{V}$, $V_{SHDN} = V_{IN}$, unless otherwise noted. (Note 2)

PARAMETER	CONDITIONS	MIN	TYP	MAX	UNITS
LED1-LED2 Current Matching	Current Into Each Pin = 20mA, $V_{LED1} = V_{LED2}$		0	1.5	%
	Current Into Each Pin = 20mA, $ V_{LED1} - V_{LED2} = 1\text{V}$		1	2.5	%
LED1 Voltage	20mA Into Pin, $V_{LED2} = 2\text{V}$, $\text{FB4} = 0$		1	1.2	V
LED2 Voltage	20mA Into Pin, $V_{LED1} = 2\text{V}$, $\text{FB4} = 0$		1	1.2	V
LED1, LED2 Maximum Current	Into Either Pin, $V_{LEDX} < 1.5\text{V}$, $\text{FB4} = 0$	35			mA
LED1, LED2 Leakage Current	$V_{SHDN} = 0\text{V}$, $V_{LEDX} = 45\text{V}$	●		1	μA
AV_{DD} Maximum Duty Cycle	SW1 Pin	88	93		%
V_{OFF} Maximum Duty Cycle	SW2 Pin	75	86		%
V_{ON} Maximum Duty Cycle	SW3 Pin	75	86		%
LED Maximum Duty Cycle	SW4 Pin	88	93		%
AV_{DD} Switch Current Limit at Minimum DC (SW1)	SW1 Pin (Note 4)	150	200	250	mA
AV_{DD} Switch Current Limit at Maximum DC (SW1)	SW1 Pin (Note 4)	80	140	200	mA
V_{OFF} Switch Current Limit at Minimum DC (SW2)	SW2 Pin (Note 4)	50	80	110	mA
V_{OFF} Switch Current Limit at Maximum DC (SW2)	SW2 Pin (Note 4)	30	60	90	mA
V_{ON} Switch Current Limit at Minimum DC (SW3)	SW3 Pin (Note 4)	50	80	110	mA
V_{ON} Switch Current Limit at Maximum DC (SW3)	SW3 Pin (Note 4)	30	60	90	mA
LED Switch Current Limit at Minimum DC (SW4)	SW4 Pin (Note 4)	550	750	900	mA
LED Switch Current Limit at Maximum DC (SW4)	SW4 Pin (Note 4)	450	600	850	mA
V_{OFF} Schottky Diode Forward Drop	D2 Pin, $I = 60\text{mA}$		0.65		V
V_{OFF} Schottky Diode Leakage Current	D2 Pin, $V_{D2} = -36\text{V}$	●		1	μA
V_{ON} Schottky Diode Forward Drop	D3 Pin, $I = 60\text{mA}$		0.65		V
V_{ON} Schottky Diode Leakage Current	$V_{D3} = 36\text{V}$, $\text{SW3} = 0\text{V}$, Output Disconnect PNP Off	●		1	μA
LED Schottky Diode Forward Drop	$I = 250\text{mA}$		0.75		V
LED Schottky Diode Leakage Current	$V_{D4} = 36\text{V}$, $\text{SW4} = 0\text{V}$	●		1	μA
Switching Frequency		0.8	1	1.2	MHz
SHDN Pin Current	$V_{SHDN} = 3\text{V}$	●	70	100	μA
	$V_{SHDN} = 0\text{V}$		20	30	nA
CTRL4 Pin Current	$V_{CTRL4} = 3\text{V}$	●	30	60	μA
	$V_{CTRL4} = 0\text{V}$		-60	-150	nA
SW1-SW4 leakage Current	$V_{SWX} = 36\text{V}$	●	0.01	1	μA
SW1 V_{CESAT}	$I_{SW1} = 100\text{mA}$ (Note 5)		200	300	mV
SW2 V_{CESAT}	$I_{SW2} = 40\text{mA}$ (Note 5)		150	250	mV
SW3 V_{CESAT}	$I_{SW3} = 40\text{mA}$ (Note 5)		150	250	mV
SW4 V_{CESAT}	$I_{SW4} = 400\text{mA}$ (Note 5)		280	400	mV
SS1 Charging Current	$V_{SS} = 0.5\text{V}$	1	3	5	μA
SS4 Charging Current	$V_{SS} = 0.5\text{V}$	1	3	5	μA
SHDN Input Voltage High		1			V
SHDN Input Voltage Low				0.4	V
CTRL4 Input Voltage High		0.25			V
CTRL4 Input Voltage Low				0.1	V

ELECTRICAL CHARACTERISTICS

The ● denotes the specifications which apply over the full operating temperature range, otherwise specifications are at $T_A = 25^\circ\text{C}$. $V_{IN} = 3.3\text{V}$, $V_{SHDN} = V_{IN}$, unless otherwise noted. (Note 2)

PARAMETER	CONDITIONS	MIN	TYP	MAX	UNITS
$\overline{\text{PGOOD}}$ Leakage Current	$\overline{\text{PGOOD}}$ NPN Off, $V_{\overline{\text{PGOOD}}} = 5\text{V}$		0	0.1	μA
$\overline{\text{PGOOD}}$ Sink Current	$\overline{\text{PGOOD}}$ NPN On, $V_{\overline{\text{PGOOD}}} = 1\text{V}$	0.5	0.7		mA
CT Charging Current			12		μA
CT Reference Voltage			0.8		V
$V_{\text{OUT}3}$ Leakage Current	Output Disconnect PNP Off, $D3 = 36\text{V}$, $V_{\text{OUT}} = 0\text{V}$		0	1	μA
$V_{\text{OUT}3}$ Source Current	Output Disconnect PNP On, $D3 = 3\text{V}$, $V_{\text{OUT}} = 2.5\text{V}$	10	15		mA
Minimum $D3/V_{\text{OUT}3}$ Operating Voltage	Minimum $D3$ Voltage for Proper Output Disconnect PNP Operation		3		V
D4 LED Open-Circuit Voltage		38	42	44	V

Note 1: Absolute Maximum Ratings are those values beyond which the life of a device may be impaired.

Note 2: The LT1942 is guaranteed to meet performance specifications from 0°C to 70°C . Specifications over the -40°C to 85°C operating temperature range are assured by design, characterization and correlation with statistical controls.

Note 3: Current flows out of the pin.

Note 4: Current limit guaranteed by design and/or correlation to static test.

Note 5: V_{CESAT} 100% tested at wafer level.

TYPICAL PERFORMANCE CHARACTERISTICS

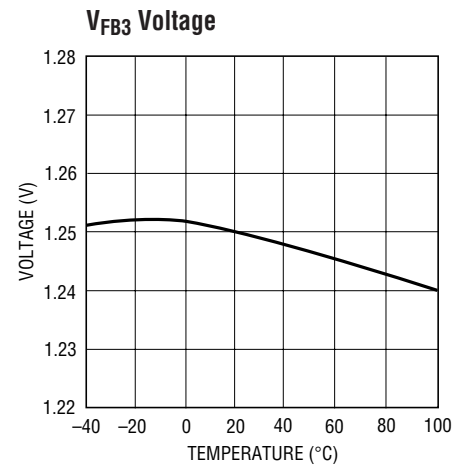
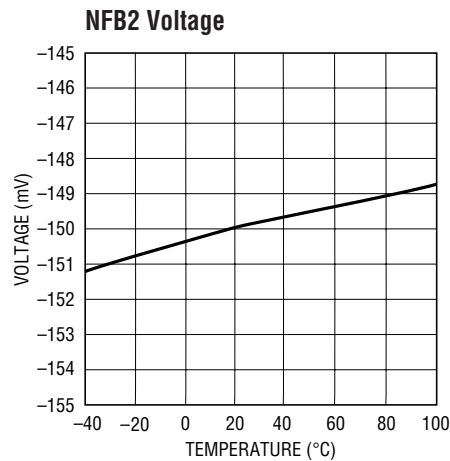
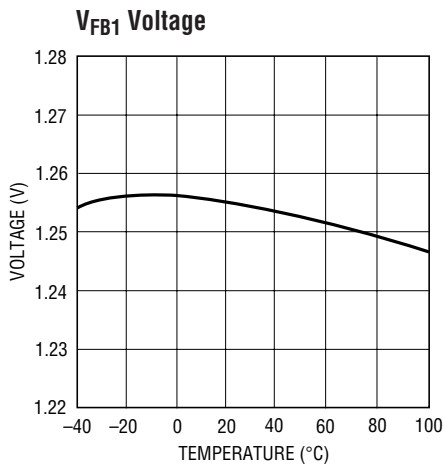

TYPICAL PERFORMANCE CHARACTERISTICS

FB4 Voltage

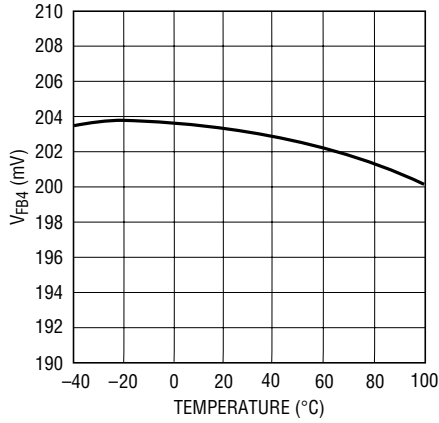

1942 G04

V_{FB4} vs CTRL4

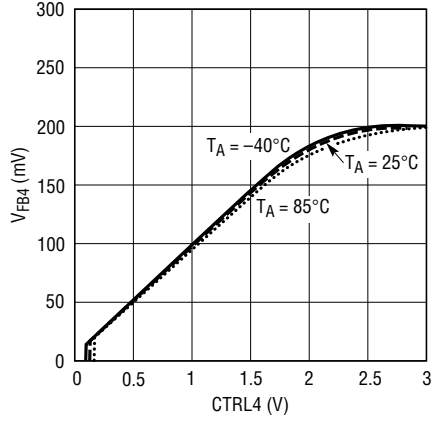

1942 G05

Oscillator Frequency

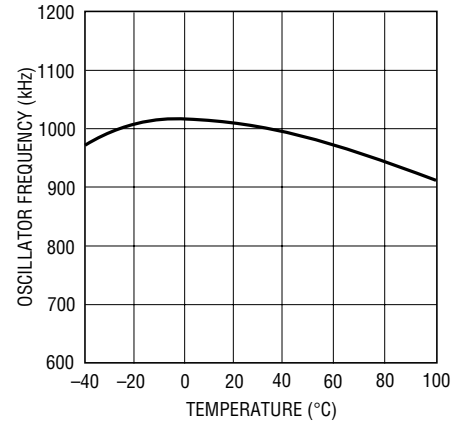

1942 G06

Quiescent Current

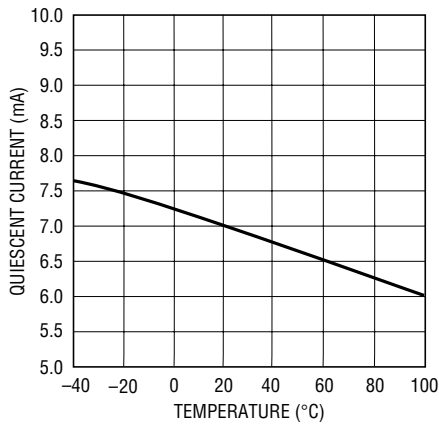

1942 G07

CT Timer Delay Time

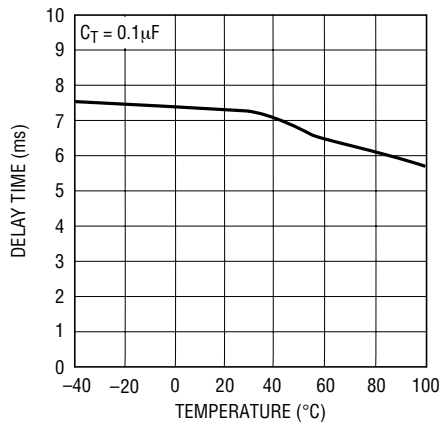

1942 G08

SW1 Saturation Voltage

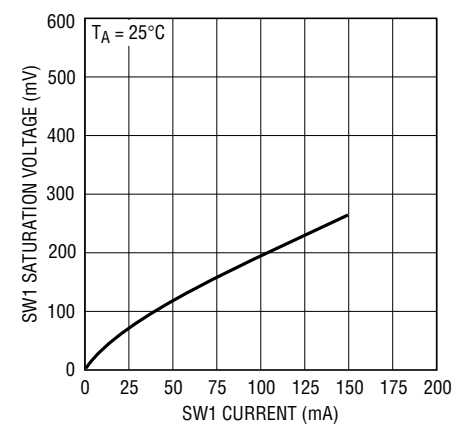

1942 G09

SW2 Saturation Voltage

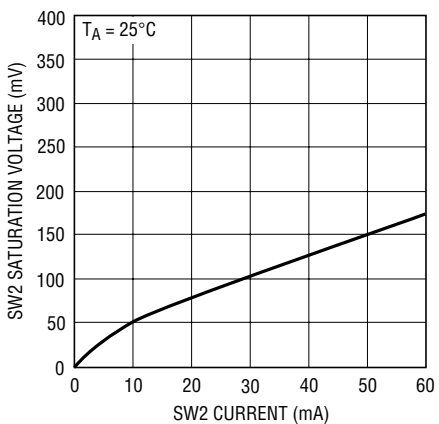

1942 G10

SW3 Saturation Voltage

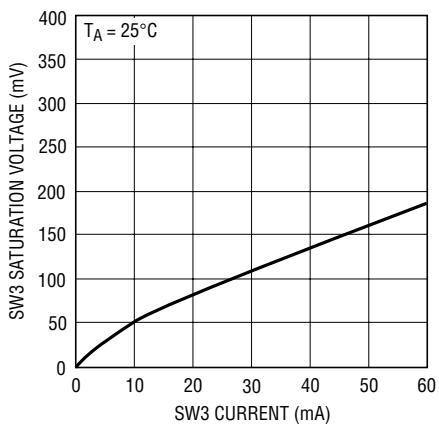

1942 G10

SW4 Saturation Voltage

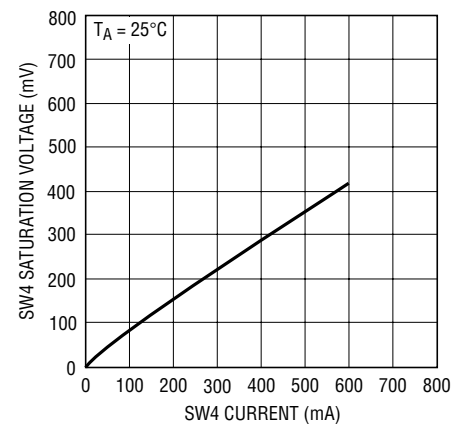

1942 G12

TYPICAL PERFORMANCE CHARACTERISTICS

LED1 to LED2 Current Matching

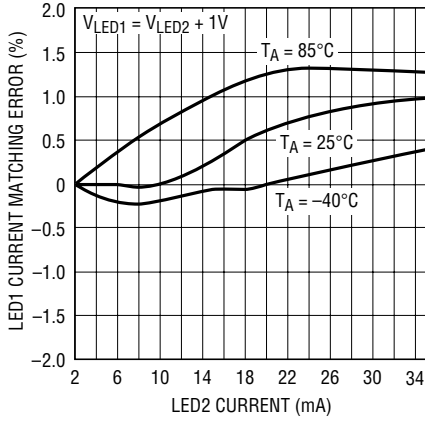

1942 G13

V_{OUT3} vs I_{OUT3}

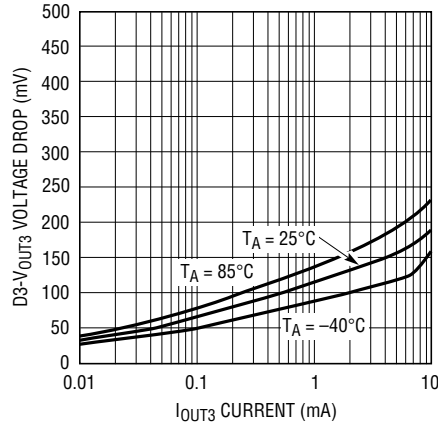

1942 G14

LED Open-Circuit Protection Voltage

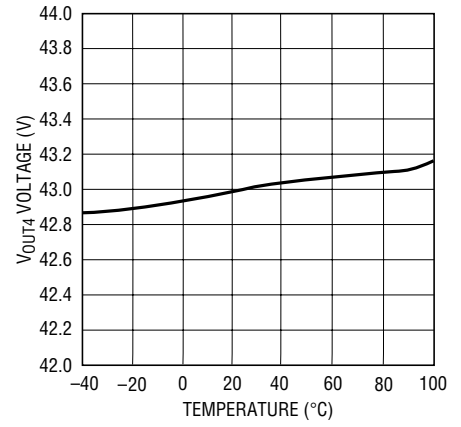

1942 G08

D4 Forward Voltage

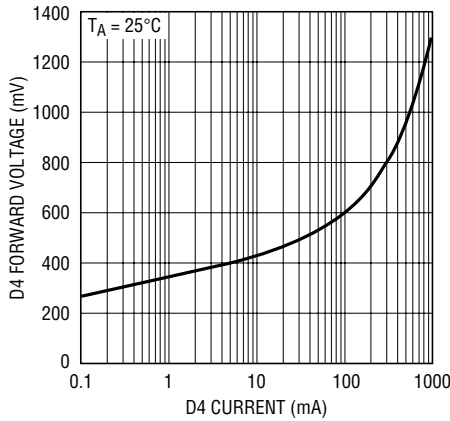

1942 G16

V_{OFF} Diode Forward Voltage

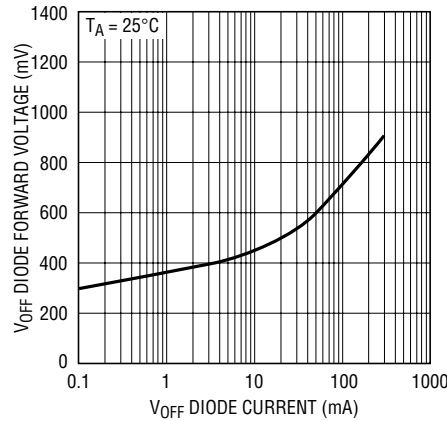

1942 G17

V_{ON} Diode Forward Voltage

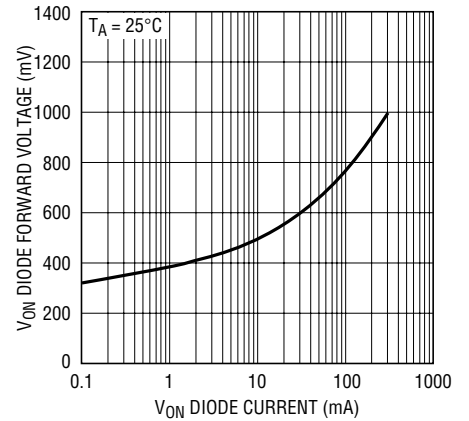

1942 G19

AV_{DD} Switcher Current Limit

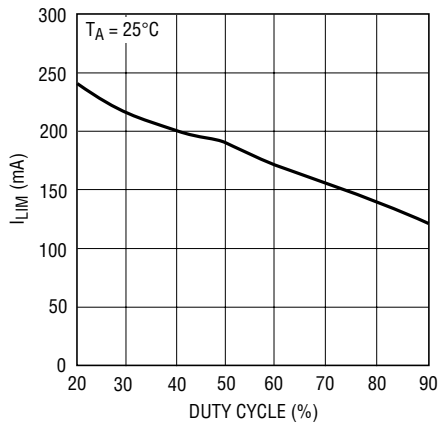

1942 G18

LED Switcher Current Limit

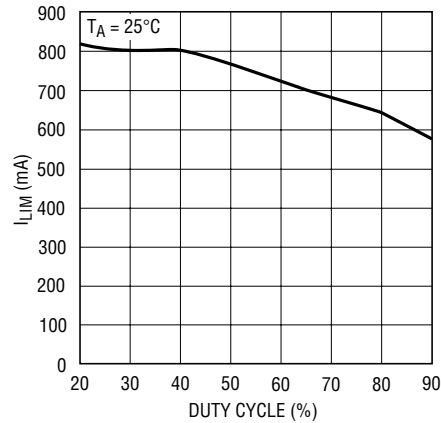

1942 G20

PIN FUNCTIONS

PGND23 (Pin 1): Power Ground for V_{OFF} and V_{ON} Switcher. Tie directly to local ground plane.

SW3 (Pin 2): Switch Pin for V_{ON} Switcher. This is the collector of an internal NPN power switch. Minimize the metal trace area connected to this pin to minimize EMI.

D3 (Pin 3): Output of V_{ON} Switcher. Place output decoupling capacitor from this pin to local ground plane.

V_{OUT3} (Pin 4): Collector of Internal Output Disconnect PNP Transistor for the V_{ON} Switcher. Place a capacitor from this pin to local ground plane of at least $0.1\mu\text{F}$.

FB3 (Pin 5): Feedback Pin for V_{ON} Switcher. Reference voltage is 1.25V . Connect resistive divider tap here. Minimize trace area at FB3. Set V_{OUT3} according to $V_{OUT3} = 1.25(1 + R5/R6)$.

NFB2 (Pin 6): Feedback Pin for V_{OFF} Switcher. Reference voltage is -150mV . Connect resistive divider tap here. Minimize trace area at NFB2. Set V_{OUT2} according to $V_{OUT2} = (-0.15)(1 + R3/R4)$.

SHDN (Pin 7): Shutdown. Tie to 1V or greater to enable the part. Tie to 0.4V or lower to disable. This pin is the global shutdown pin for all four switching regulators.

CTRL4 (Pin 8): Shutdown for the LED Switcher. Tie to 0.25V or greater to enable the LED switcher. Tie to 0.1V or lower to disable. CTRL4 can also override the default 200mV reference for the LED switcher. If CTRL4 is tied to 2.5V or greater, the reference voltage is 200mV . If CTRL4 is less than 2.5V , the LED reference voltage is approximately $V_{CTRL4}/10$. This allows an 8:1 dimming range for the LEDs. Refer to the Applications Section for more information.

CT (Pin 9): Programmable Delay for the TFT Supplies. Place a capacitor from this pin to local ground plane. After the delay, the output disconnect PNP for the V_{ON} supply is turned on. The delay time is initiated when AV_{DD} reaches 97% of its final value.

AGND (Pin 10): Analog Ground. Tie directly to local ground plane.

SS1 (Pin 11): Soft-Start Pin for AV_{DD} Switcher. Place a soft-start capacitor from this pin to ground. Upon start-up, $4\mu\text{A}$ of current charges the capacitor to 1.25V . Use larger capacitor for slower start-up. Leave floating if not in use.

SS4 (Pin 12): Soft-Start for LED Switcher. Place a soft-start capacitor from this pin to ground. Upon start-up, $4\mu\text{A}$ of current charges the capacitor to 1.25V . Use larger capacitor for slower start-up. Leave floating if not in use.

PGOOD (Pin 13): Power Good Indication for AV_{DD} Switcher. Open-collector NPN. Stays open until the V_{FB1} voltage reaches 97% of target value at which point the pin will pull down.

FB1 (Pin 14): Feedback Pin for AV_{DD} Switcher. Connect resistive divider tap here. Minimize trace area at FB1. Set V_{OUT1} according to $V_{OUT1} = 1.25(1 + R1/R2)$.

FB4 (Pin 15): Feedback Pin for LED Switcher. Place a resistor from this node to ground. Choose $R7$ to set LED current (I_{LED}) according to the following formula:

$$\text{if } V_{CTRL4} \geq 2.5\text{V}, R7 = 0.2/I_{LED}$$

In this case, I_{LED} is the total LED current. If two strings of LEDs are used, I_{LED} is the sum of the current in the two strings. If only a single string of LEDs is used, I_{LED} is simply the single string current. For dimming LED current, drive V_{CTRL4} to a lower voltage. See the Applications Section for more information.

D4 (Pin 16): Output of LED Switcher. Place output decoupling capacitor from this pin to local ground plane.

LED2 (Pin 17): Second Input of Current Mirror for an LED String. Connect the negative end of second string of LEDs to this pin. If not in use, leave floating.

PIN FUNCTIONS

LED1 (Pin 18): First Input of Current Mirror for an LED String. Connect the negative end of first string of LEDs to this pin. If not in use, leave floating.

SW4 (Pin 19): Switch Pin for LED Switcher. This is the collector of an internal NPN power switch. Minimize the metal trace area connected to this pin to minimize EMI.

SW1 (Pin 20): Switch Pin for AV_{DD} Switcher. This is the collector of an internal NPN Power switch. Minimize the metal trace area connected to this pin to minimize EMI.

PGND14 (Pin 21): Power Ground for LED Switcher and AV_{DD} Switcher. Tie directly to local ground plane.

V_{CC} (Pin 22): Input Supply. Must be locally bypassed.

D2 (Pin 23): Anode Connection of Internal Schottky Diode for V_{OFF} Switcher.

SW2 (Pin 24): Switch Pin for V_{OFF} Switcher. This is the collector of an internal NPN Power switch. Minimize the metal trace area connected to this pin to minimize EMI.

SGND (Pin 25): Signal Ground. This is the Exposed Pad, which must be soldered directly to a local ground plane to achieve optimum thermal performance.

BLOCK DIAGRAM

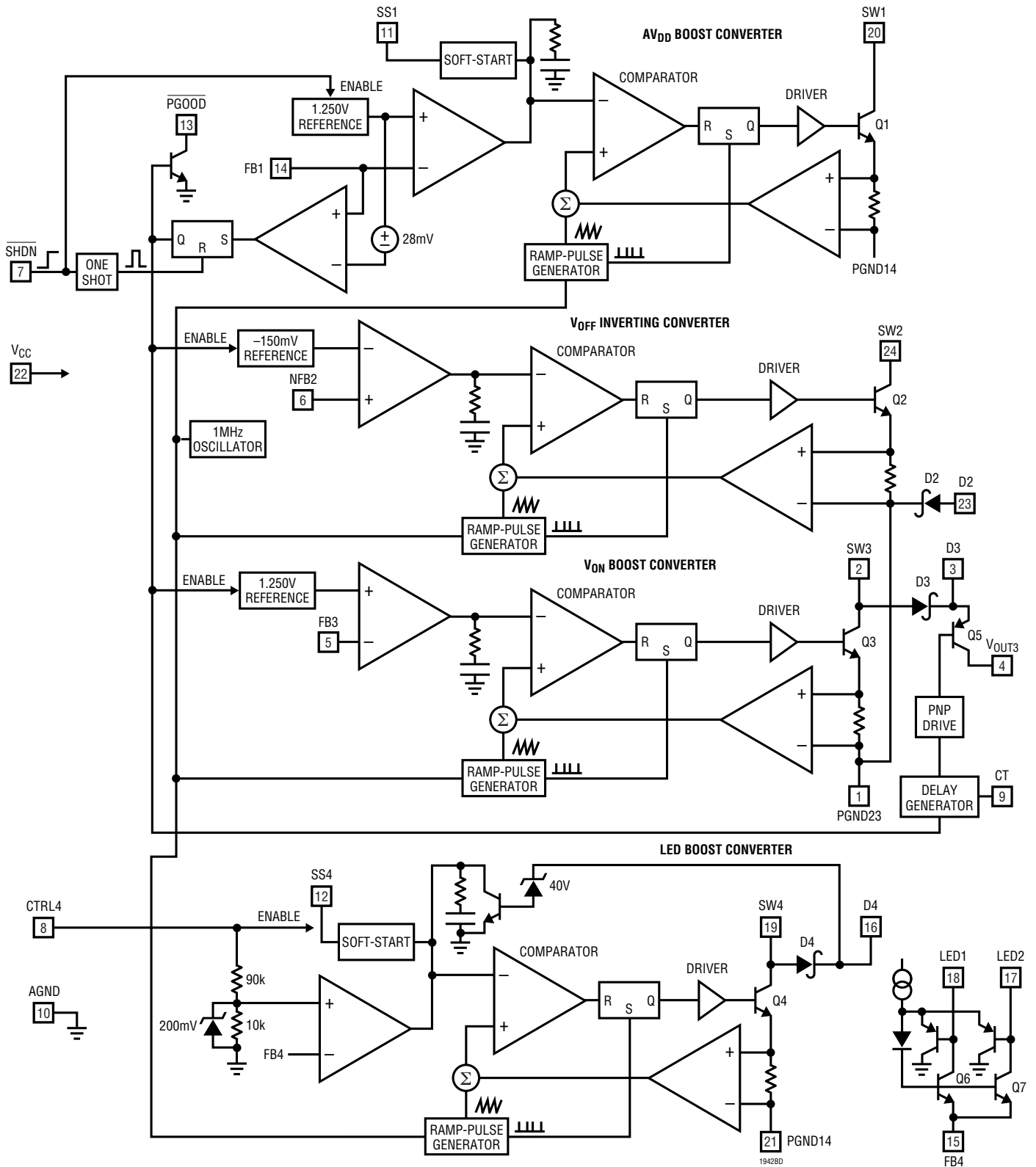

OPERATION

Refer to the figure on the first page of this data sheet and the Block Diagram when following the description of the operation of the LT1942. The LT1942 contains four switching regulators. Three switchers are designed to be used as the power supply for driving small to medium sized TFT displays. The fourth switcher is designed to power an LED backlight. All four switching regulators use a constant frequency, current mode control scheme to provide excellent line and load regulation.

TFT Supply

The three switching regulators for the TFT supply are named AV_{DD} , V_{OFF} and V_{ON} . Both the AV_{DD} and V_{ON} switchers are boost type, while the V_{OFF} is an inverting type. Power sequencing circuitry is integrated into the LT1942 to properly power up the TFT power supply. When the SHDN pin is driven above 1V initially, only the AV_{DD} switcher is enabled. After the output of the AV_{DD} switcher reaches 97% of its final value, the PGOOD pin is driven low and both the V_{OFF} and V_{ON} switchers are enabled. This event is latched rejecting any later drops on AV_{DD} below 97%. The output-disconnect circuitry (Q5 in the Block Diagram) for the V_{ON} switcher is not activated until the programmable delay set by the CT pin has elapsed. Once the output-disconnect circuitry is enabled, the V_{OUT3} pin is driven to nearly the same voltage as D3. The V_{OUT3} pin can only source current and is limited to 15mA nominally. All three switching regulators are internally compensated and operated at a fixed frequency of 1MHz. The AV_{DD} switching regulator has integrated soft-start. Simply place a capacitor from the SS1 pin to GND to implement soft-start.

LED Supply

The fourth switching regulator in the LT1942 is designed to drive up to 20 LEDs (2 strings of 10) to power a backlight. The LED switcher has an integrated current ballaster (Q6 and Q7 in the Block Diagram) which enables two strings of LEDs to have active current matching. The current into LED1 and LED2 will always be actively matched, regardless of which LED string has the highest voltage drop. The LED ballast circuitry can be left unused when driving a single string of LEDs. Simply leave the LED1 and LED2 inputs floating and return the LED string directly to the FB4 pin. The LED switcher has an independent control pin which serves two functions: shutdown and reference adjustment. The CTRL4 pin needs to be driven above 0.25V to enable the LED switcher. When CTRL4 is between 0.25V and 2.5V, the internal reference for the LED switcher is attenuated. If CTRL4 is above 2.5V, the internal reference is limited to 200mV no matter how high CTRL4 is. This feature allows an 8:1 dimming range for the LEDs. The LED switching regulator is internally compensated and operates at a fixed frequency of 1MHz. The LED switching regulator has LED open-circuit protection. If any LED fails open, D4 is not allowed to exceed 42V (typical). This prevents damage to the power switch. The LED switching regulator also has built in soft-start. By placing a capacitor from the SS4 pin to GND, the user can program the soft-start time.

APPLICATIONS INFORMATION

Setting the Output Voltages

Unlike charge-pump-based TFT supplies, the LT1942 TFT outputs can all be independently set. The AV_{DD} , V_{OFF} and V_{ON} outputs are all inductively based DC/DC converters. As such, the output voltages are set by choosing the right feedback divider ratio. The AV_{DD} feedback pin is FB1 and the reference voltage is 1.25V. The V_{OFF} feedback pin is NFB2 and the reference voltage is -150mV . The V_{ON} feedback pin is FB3 and the reference voltage is 1.25V. The LED driver is also an inductively based DC/DC converter.

Output Disconnect

The V_{ON} switching regulator has built in output disconnect. When the V_{ON} supply is enabled, the boost converter will charge up the D3 node. With the output disconnect PNP (Q5) turned off, the voltage on V_{OUT3} will be zero. Once the power sequencing circuitry turns on the PNP, V_{OUT3} will go to nearly the same voltage as D3.

The V_{OFF} switching regulator naturally achieves output disconnect due to the switching topology (inverting configuration). When the LT1942 is in shutdown, V_{OFF} will go to zero volts.

The AV_{DD} switching regulator provides a $\overline{\text{PGOOD}}$ pin to be used for an external output disconnect function. This pin can drive the gate of a PMOS device. When the LT1942 is first enabled, the AV_{DD} switching regulator begins to charge up the output capacitor. Since $\overline{\text{PGOOD}}$ is still an open collector at this point, the PMOS device is turned off, leaving the AV_{DD} output at zero volts. Once the output capacitor charges to 97% of the final value, $\overline{\text{PGOOD}}$

latches low turning on the PMOS device and bringing the AV_{DD} output quickly to the desired voltage.

Soft-Start

The higher current regulators, AV_{DD} and LED, have user programmable soft-start functions built into the part. Simply place a capacitor from the SS1 pin to GND to achieve soft-start for the AV_{DD} switcher. For the LED switcher, place a capacitor from the SS4 pin to GND. A good value for both soft-start capacitors is $0.1\mu\text{F}$. The soft-start time is dependent on the load characteristics which will vary depending on the type and size of the TFT display. It is a good practice to experiment to determine the best value for the soft-start capacitors.

Power Sequencing

The TFT supply has integrated supply sequencing built-in to ensure proper initiation of the TFT display. Figure 1 shows a state diagram of the power sequencing circuitry. The power sequencing circuitry insures that the AV_{DD} supply comes up first, then the negative V_{OFF} supply and lastly the V_{ON} positive supply. To pick the CT capacitor for a particular delay, use the following equation:

$$C_T = \frac{10\mu\text{A} \cdot t_{\text{DELAY}}}{0.7\text{V}}$$

Figure 2 shows the power sequencing during start-up of the TFT power supply for the circuit shown in the figure on the first page of this data sheet. All bias supplies start up in a well controlled and well timed manner. The LED backlight driver is independently controlled via the CTRL4 pin.

APPLICATIONS INFORMATION

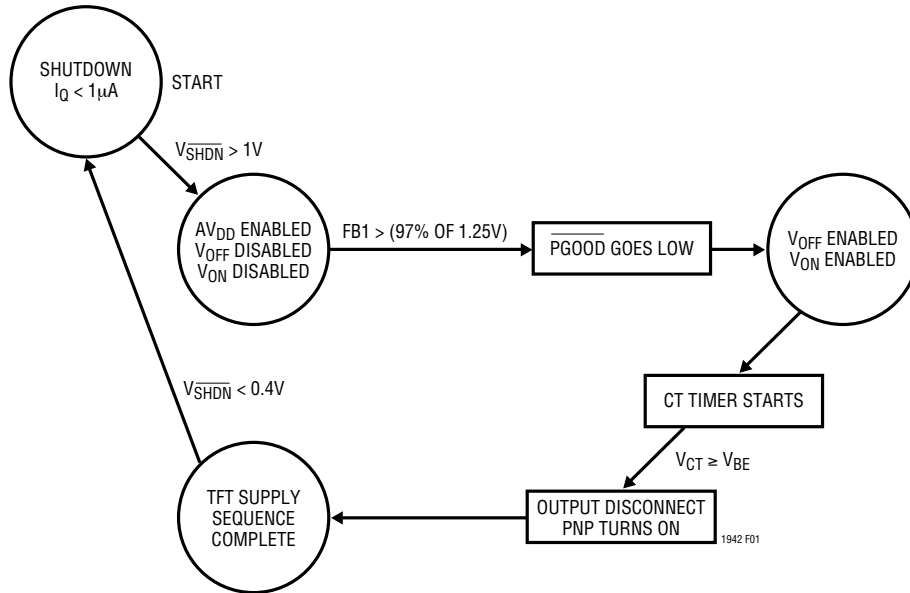

Figure 1. Power Sequencing State Diagram

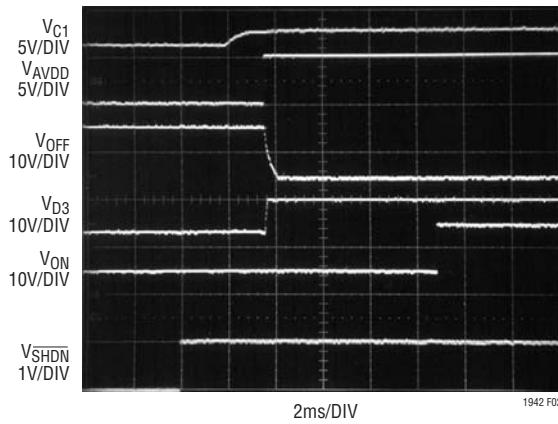

Figure 2. Power Sequencing During TFT Supply Start-Up (Refer to Figure 4 Node Names)

APPLICATIONS INFORMATION

Layout Hints

Proper layout techniques must be followed to achieve advertised performance of the part. Keep all SW and FB traces short and small. There are several power ground pins on the LT1942 and it is important to implement the grounding properly. PGND14 is the power ground pin for the AV_{DD} and LED switchers. The output capacitor for both the AV_{DD} and LED switcher must be returned back to this pin before being allowed to mix into the ground plane.

Similarly, PGND23 is the power ground pin for the V_{ON} and V_{OFF} switcher. Again, both output capacitors for the V_{ON} and V_{OFF} switchers need to return to the PGND23 pin before mixing with the ground plane. Place the input decoupling capacitor, which ties from the V_{CC} pin to GND, as close to the part as possible. Please refer to Figure 3 for a recommended layout of the power path components. The component names are those shown in the circuit of Figure 4.

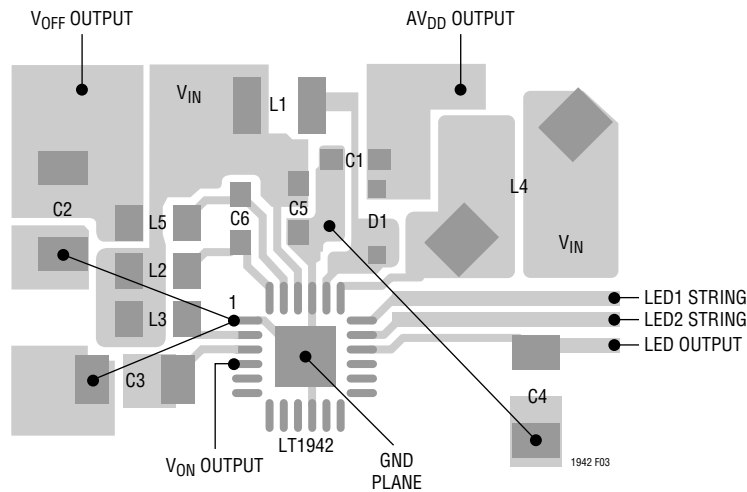

Figure 3: Power Path Component Recommended Layout (Refer to Figure 4 Component Names)

TYPICAL APPLICATIONS

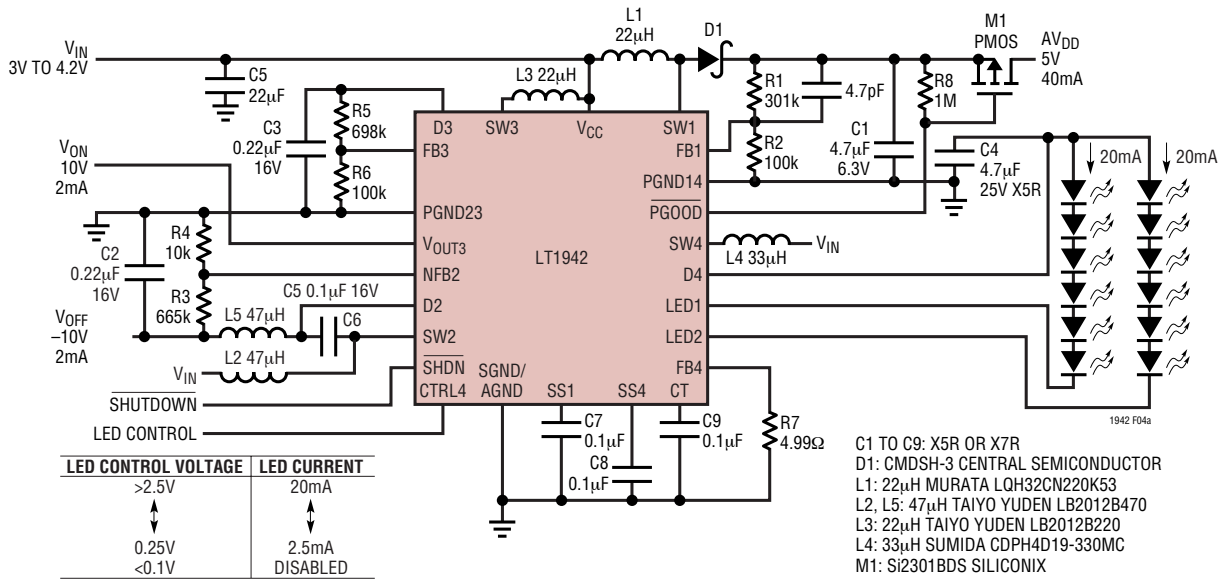
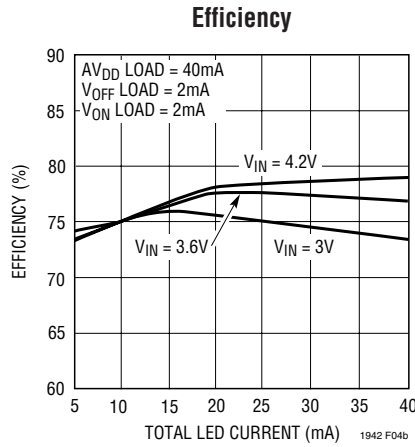
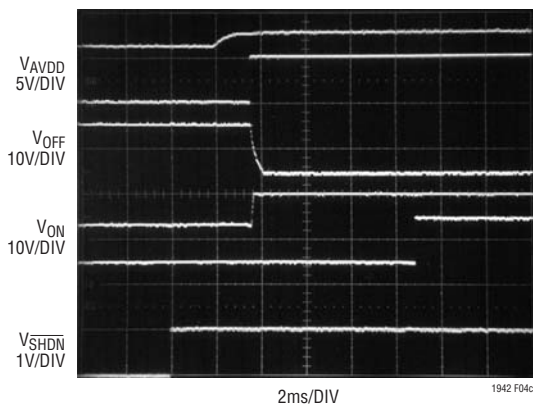

Figure 4. TFT Bias (5V, 10V, -10V) and White LED Backlight Supply from Single Li-Ion Cell



TFT Power Supply Sequencing



AVDD Transient Response, ILOAD Stepped from 30mA → 40mA → 30mA

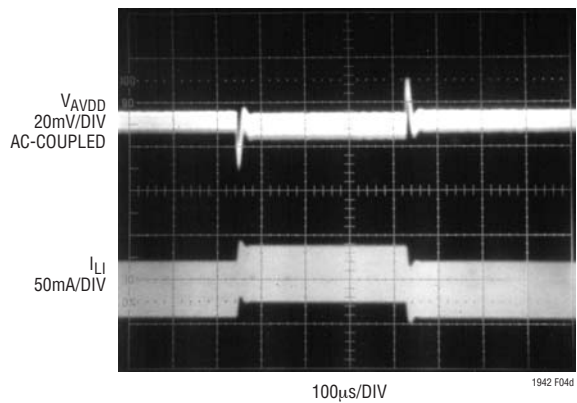

PACKAGE DESCRIPTION

UF Package
24-Lead Plastic QFN (4mm × 4mm)
 (Reference LTC DWG # 05-08-1697)

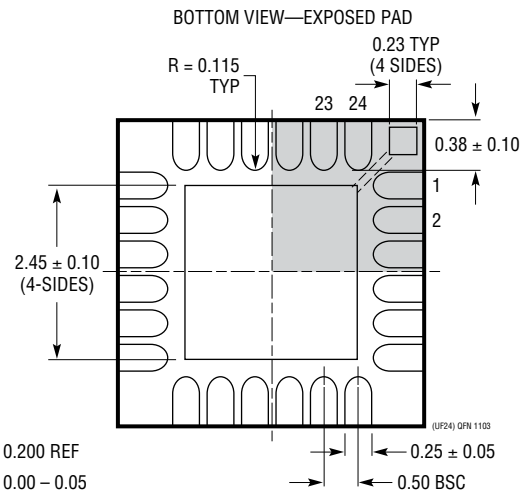
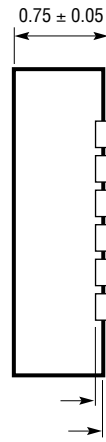
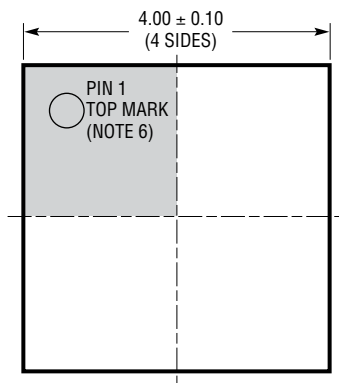
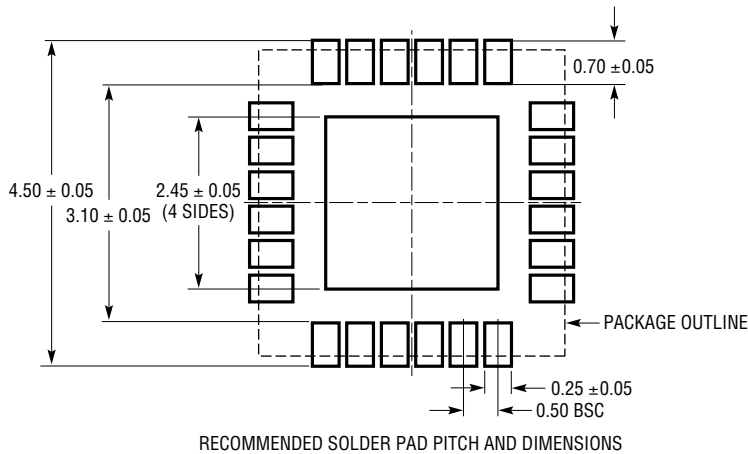

- NOTE:
1. DRAWING PROPOSED TO BE MADE A JEDEC PACKAGE OUTLINE MO-220 VARIATION (WGGD-X)—TO BE APPROVED
 2. DRAWING NOT TO SCALE
 3. ALL DIMENSIONS ARE IN MILLIMETERS
 4. DIMENSIONS OF EXPOSED PAD ON BOTTOM OF PACKAGE DO NOT INCLUDE MOLD FLASH. MOLD FLASH, IF PRESENT, SHALL NOT EXCEED 0.15mm ON ANY SIDE, IF PRESENT
 5. EXPOSED PAD SHALL BE SOLDER PLATED
 6. SHADED AREA IS ONLY A REFERENCE FOR PIN 1 LOCATION ON THE TOP AND BOTTOM OF PACKAGE

RELATED PARTS

PART NUMBER	DESCRIPTION	COMMENTS
LT1613	550mA (I_{SW}), 1.4MHz High Efficiency Step-Up DC/DC Converter	V_{IN} : 0.9V to 10V, $V_{OUT(MAX)}$ = 34V, I_Q = 3mA, I_{SD} < 1 μ A, ThinSOT Package
LT1615/LT1615-1	300mA/80mA (I_{SW}), Constant Off-Time, High Efficiency Step-Up DC/DC Converter	V_{IN} : 1.2V to 15V, $V_{OUT(MAX)}$ = 34V, I_Q = 20 μ A, I_{SD} < 1 μ A, ThinSOT Package
LT1930/LT1930A	1A (I_{SW}), 1.2MHz/2.2MHz High Efficiency Step-Up DC/DC Converter	V_{IN} : 2.6V to 16V, $V_{OUT(MAX)}$ = 34V, I_Q = 4.2mA/5.5mA, I_{SD} < 1 μ A, ThinSOT Package
LT1932	Constant Current, 1.2MHz, High Efficiency White LED Boost Regulator	V_{IN} : 1V to 10V, $V_{OUT(MAX)}$ = 34V, I_Q = 1.2mA, I_{SD} < 1 μ A, ThinSOT Package
LT1943 (Quad)	Quad Output, 2.6A Buck, 2.6A Boost, 0.3A Boost, 0.4A Inverter, 1.2MHz TFT DC/DC Converter	V_{IN} : 4.5V to 22V, $V_{OUT(MAX)}$ = 40V, I_Q = 10mA, I_{SD} < 35 μ A, TSSOP28E Package
LT1944/LT1944-1 (Dual)	Dual Output 350mA/100mA (I_{SW}), Constant Off-Time, High Efficiency Step-Up DC/DC Converter	V_{IN} : 1.2V to 15V, $V_{OUT(MAX)}$ = 34V, I_Q = 20 μ A, I_{SD} < 1 μ A, MS10 Package
LT1945	Dual Output, Pos/Neg, 350mA (I_{SW}), Constant Off-Time, High Efficiency Step-Up DC/DC Converter	V_{IN} : 1.2V to 15V, $V_{OUT(MAX)}$ = \pm 34V, I_Q = 20 μ A, I_{SD} < 1 μ A, MS10 Package
LT1947	Adjustable Output TFT-LCD Triple Switching Regulator	V_{IN} : 2.7V to 8V, $V_{OUT(MAX)}$ = 30V, I_Q = 9.5mA, I_{SD} < 1 μ A, MS10 Package
LTC3450	Triple Output Power Supply for Small TFT-LCDs	V_{IN} : 1.5V to 4.6V, $V_{OUT(MAX)}$ = \pm 15V, I_Q = 75 μ A, I_{SD} < 1 μ A, DFN Package
LT3461/LT3461A	0.3A (I_{SW}), 1.3MHz/3MHz, High Efficiency Step-Up DC/DC Converter with Integrated Schottky	V_{IN} : 2.5V to 16V, $V_{OUT(MAX)}$ = 38V, I_Q = 2.8mA, I_{SD} < 1 μ A, SC70, ThinSOT Packages
LT3464	0.08A (I_{SW}), High Efficiency Step-Up DC/DC Converter with Integrated Schottky, Output Disconnect	V_{IN} : 2.3V to 10V, $V_{OUT(MAX)}$ = 34V, I_Q = 25 μ A, I_{SD} < 1 μ A, ThinSOT Package
LT3465/LT3465A	Constant Current, 1.2MHz/2.7MHz High Efficiency White LED Boost Regulator with Integrated Schottky	V_{IN} : 2.7V to 16V, $V_{OUT(MAX)}$ = 34V, I_Q = 1.9mA, I_{SD} < 1 μ A, ThinSOT Package
LT3466	Dual Constant Current, 2MHz, High Efficiency White LED Boost Regulator with Integrated Schottky	V_{IN} : 2.7V to 24V, $V_{OUT(MAX)}$ = 40V, I_Q = 5mA, I_{SD} < 16 μ A, DFN Package
LT3467/LT3467A	1.1A (I_{SW}), 1.3MHz/2.1MHz, High Efficiency Step-Up DC/DC Converter with Integrated Soft-Start	V_{IN} : 2.4V to 16V, $V_{OUT(MAX)}$ = 40V, I_Q = 1.2mA, I_{SD} < 1 μ A, ThinSOT Package